

Acoustic Ceiling Panel Installation Using **RONDO KEY-LOCK®** Ceiling System

**CONCEALED SUSPENDED CEILING INSTALLATION**

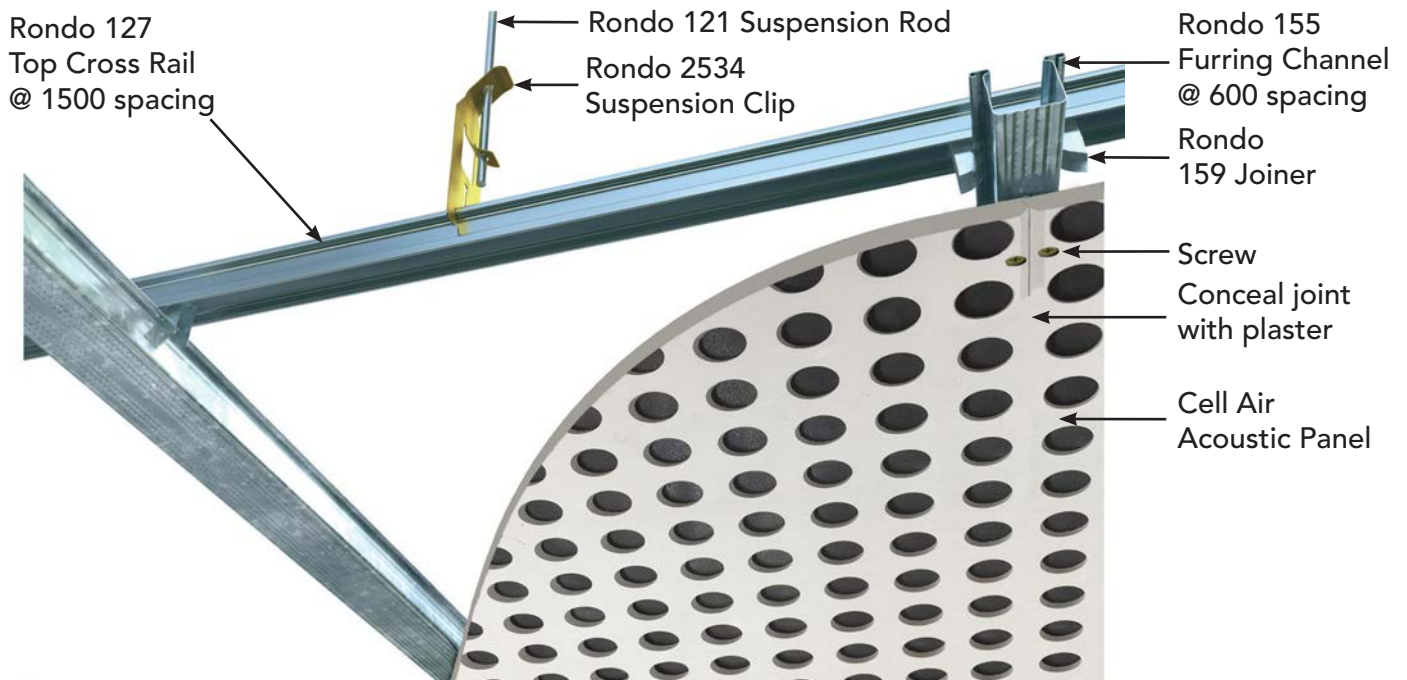

**BOTTOM VIEW** Typical Ceiling Installation with **RONDO KEY-LOCK®** Ceiling System

**RONDO KEY-LOCK® Components**

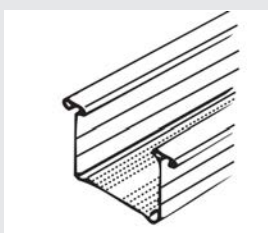

155 Furring Channel

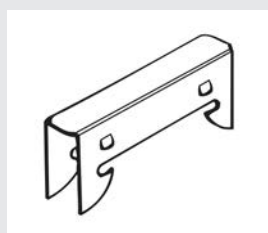

159 Joiner

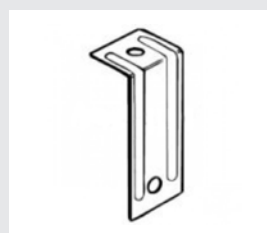

Rondo 247 Suspension Rod Bracket



Rondo 2534 Suspension Clip

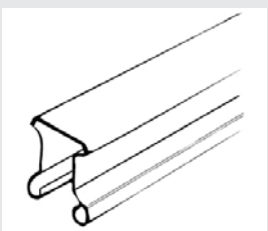

Rondo 127 Top Cross Rail

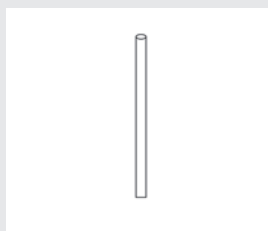

Rondo 121 Suspension Rod

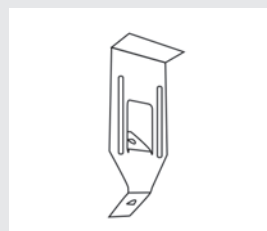

Rondo 547 Adjustable Suspension Hanger

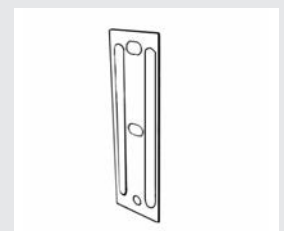

Rondo 274 Suspension Bracket

## CONCEALED SUSPENDED CEILING INSTALLATION

### Direct Fixing Clip Options to Timber or Steel Purlins

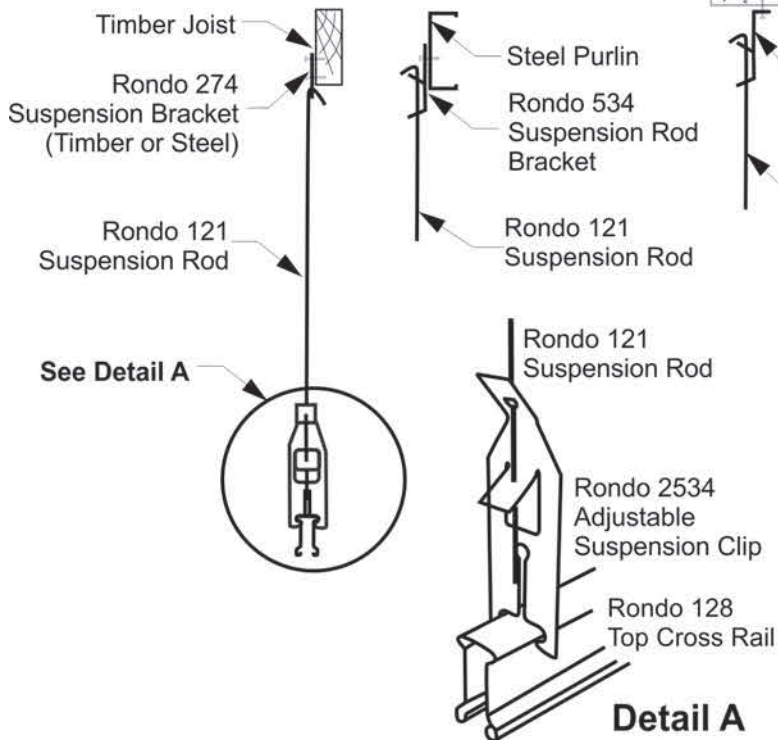

### Direct Fixing Clip Options to Concrete

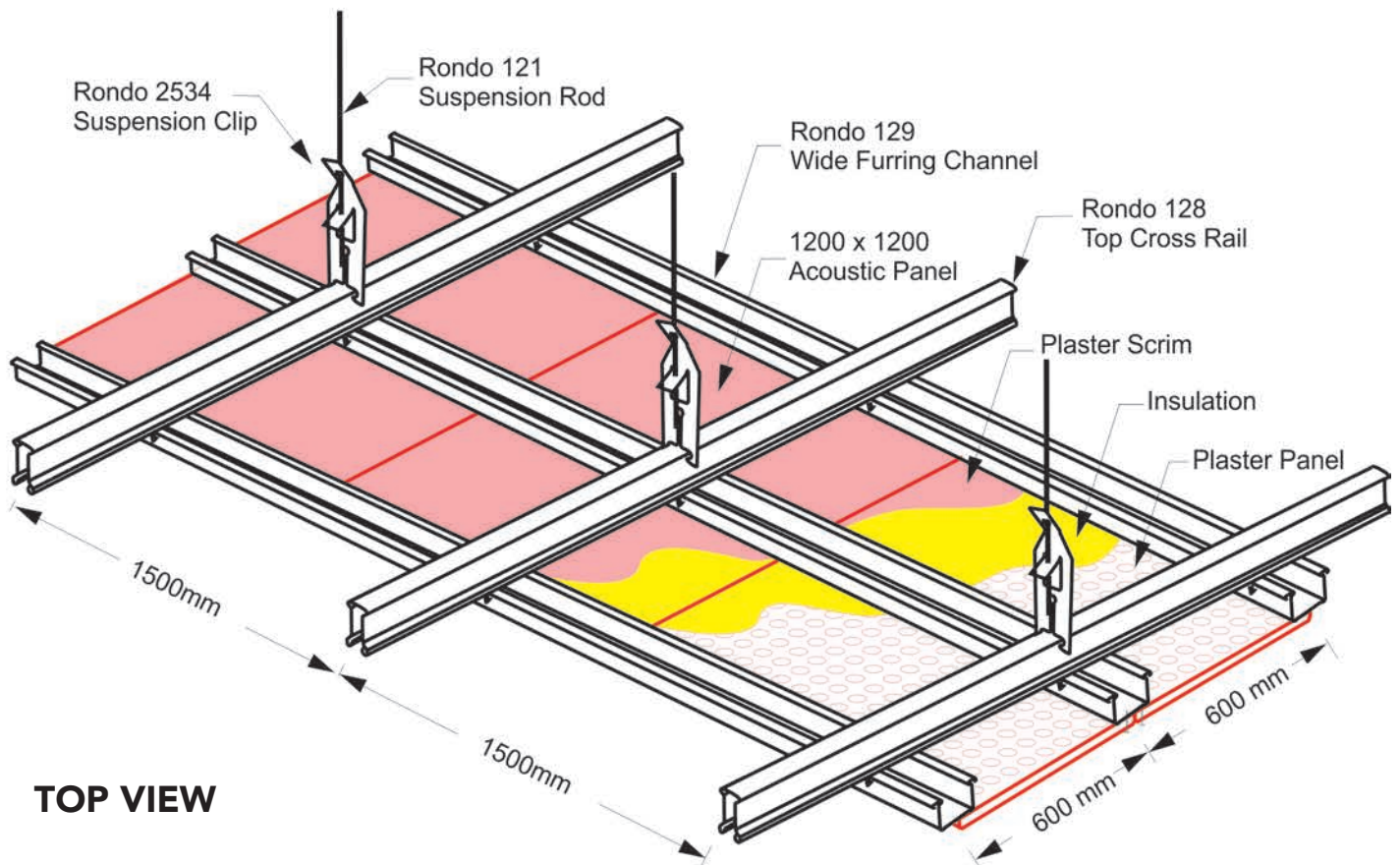
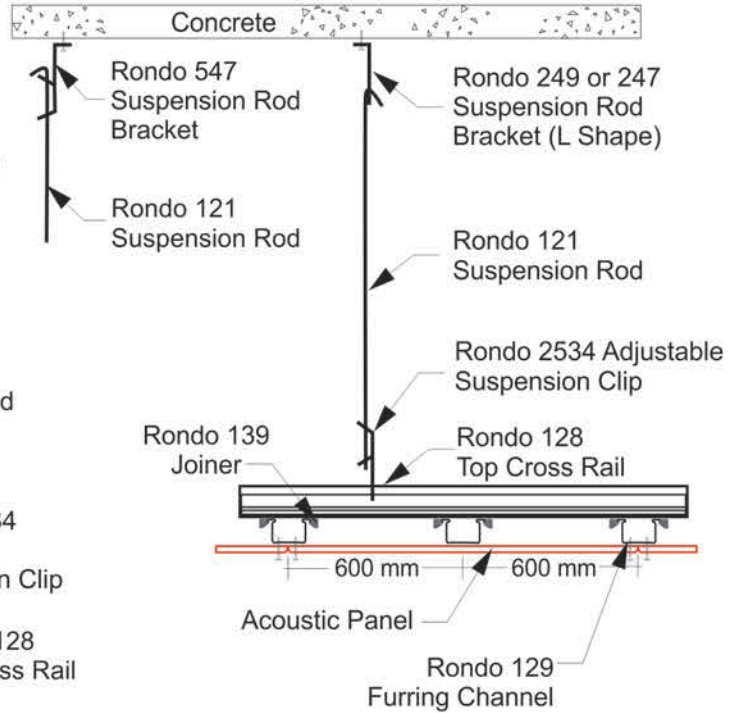

## DIRECT FIX CEILING INSTALLATION

Typical Direct Ceiling Installation with RONDO KEY-LOCK® Components

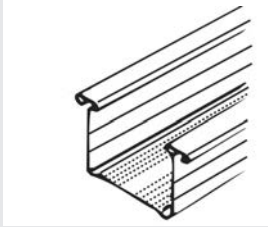

155 Furring Channel

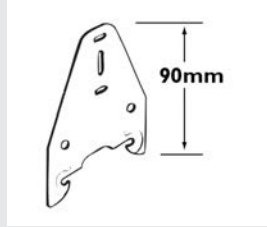

156 Direct Fix Clip

The 156 Direct Fix Clip is able to fix the 155 Furring Channel to steel purlins or timber joists in ceiling applications as well as to steel girts or timber stud work in walls.

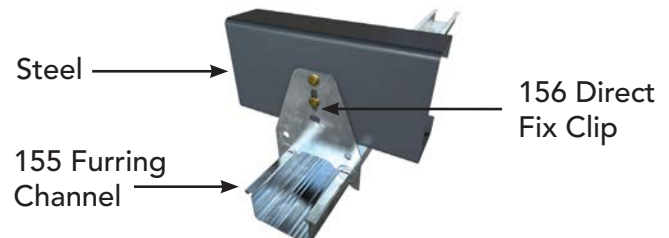
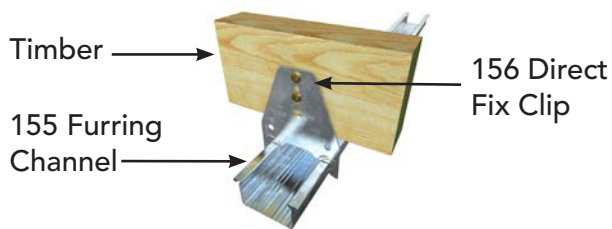





Acoustic Panel Wall Installation Using Rondo Internal Express Joint Wall

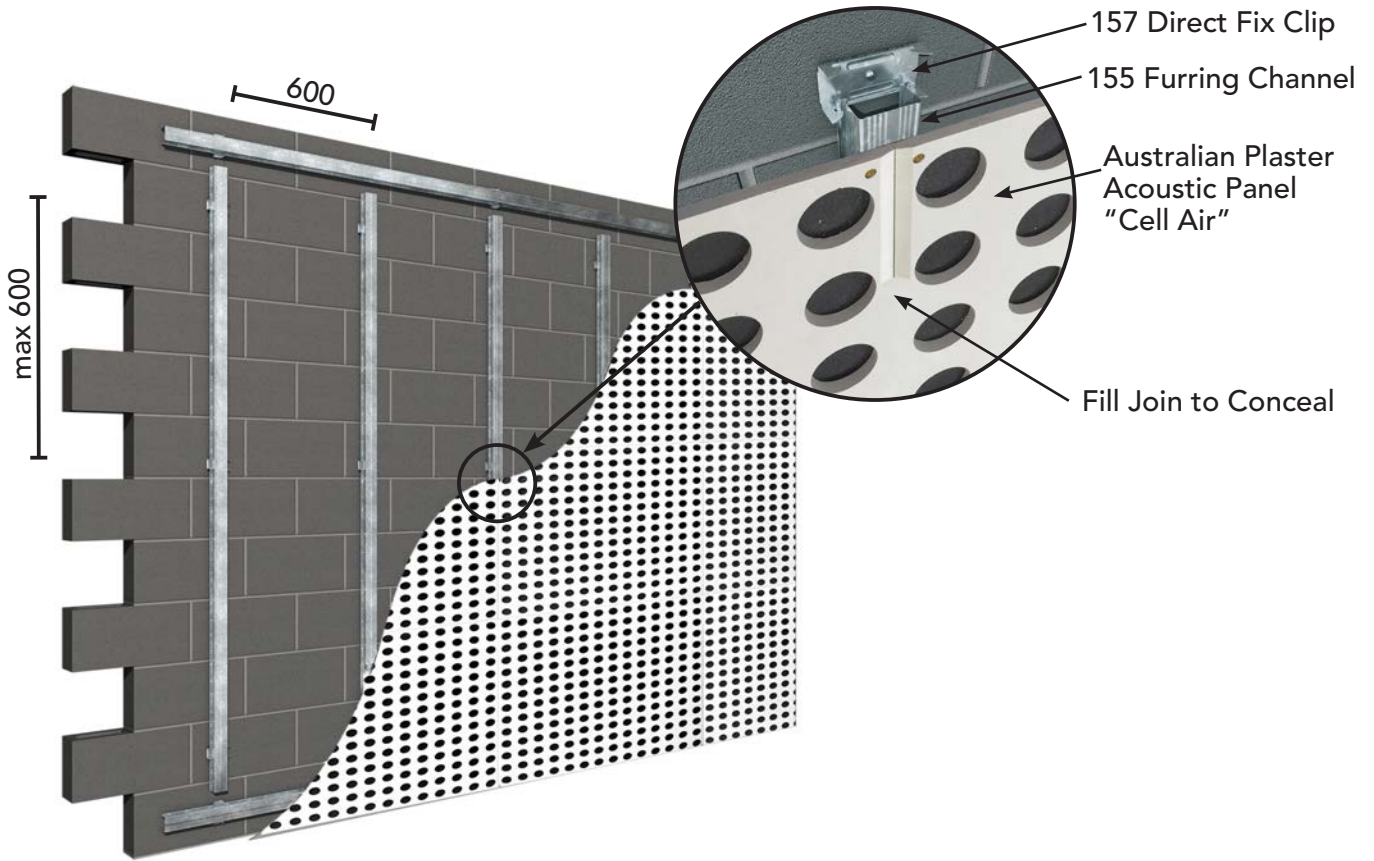

Typical Wall Installation with RONDO KEY-LOCK® Components

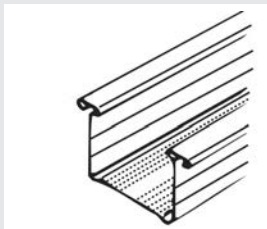

155 Furring Channel

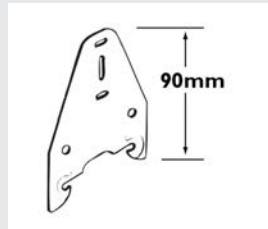

156 Direct Fix Clip

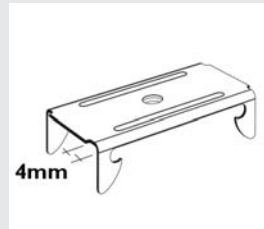

157 Direct Fix Clip

The 156 Direct Fix Clip is able to fix the 155 Furring Channel to steel purlins or timber joists in ceiling applications as well as to steel girts or timber stud work in walls.

